

TEGULA ART

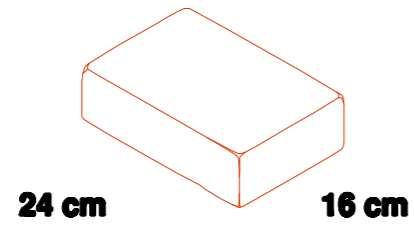

24 cm 16 cm

24 x 16
Espesor 6/7 cm
26.04 Unidades m2

TERANA ART

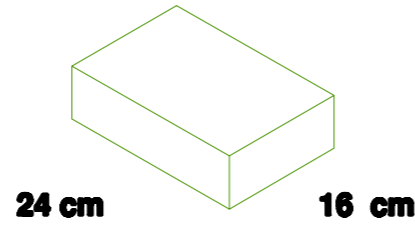

24 cm 16 cm

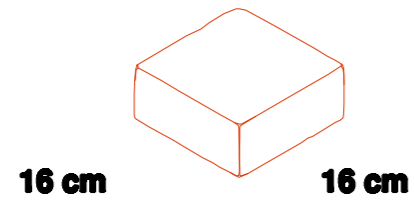

16 cm 16 cm

16 x 16
Espesor 6/7 cm
39.06 Unidades m2

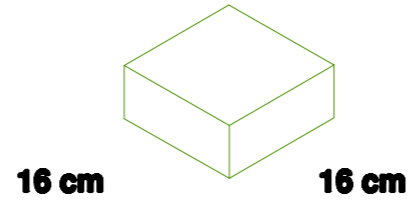

16 cm 16 cm

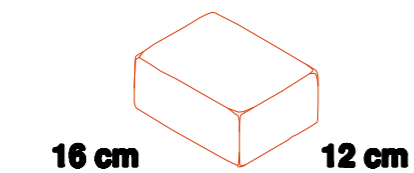

16 cm 12 cm

16 x 12
Espesor 6/7 cm
52.08 Unidades m2

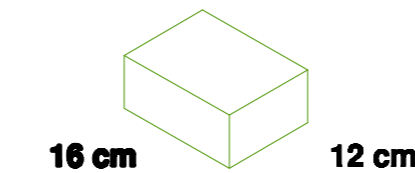

16 cm 12 cm

CARACTERISTICAS GEOMETRICAS

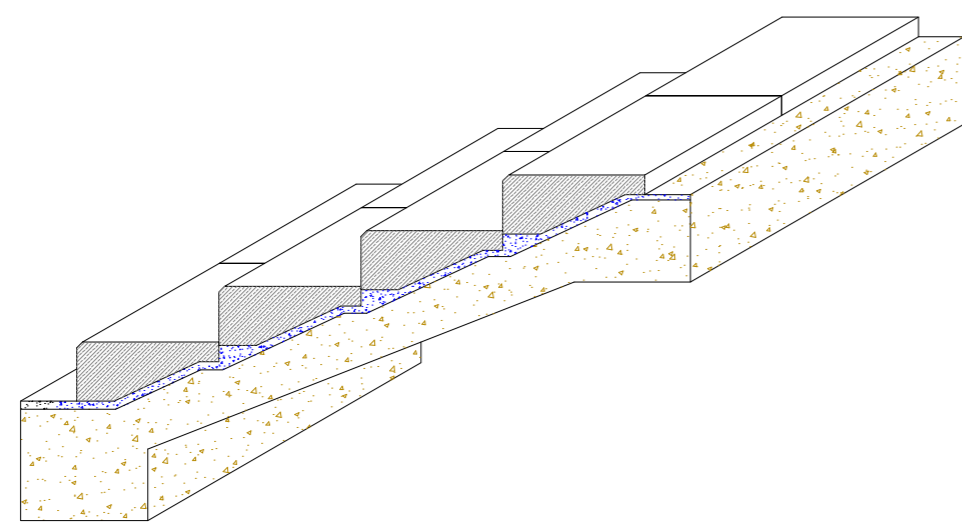

ESQUEMA DE COLOCACION

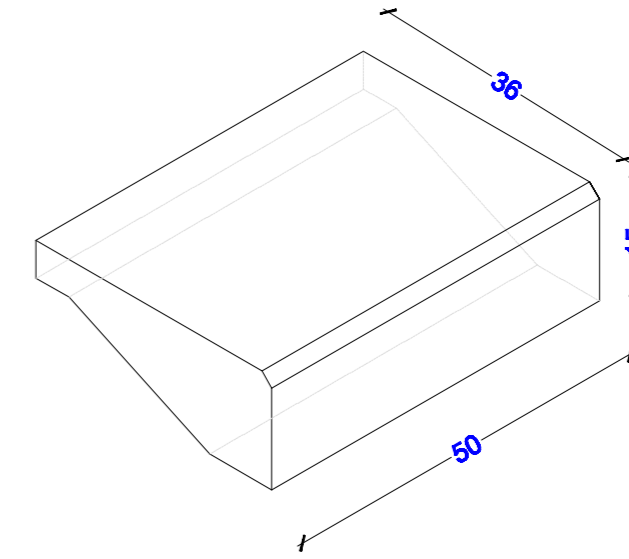
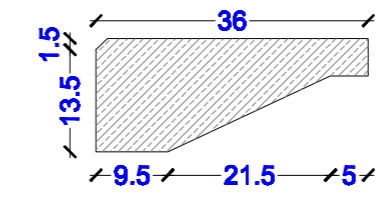
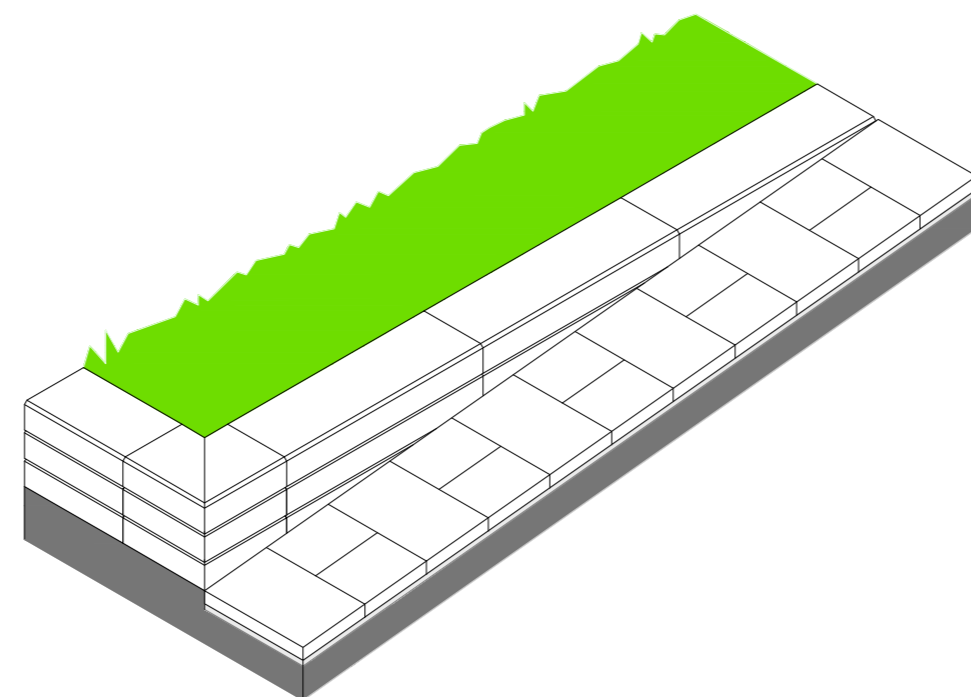
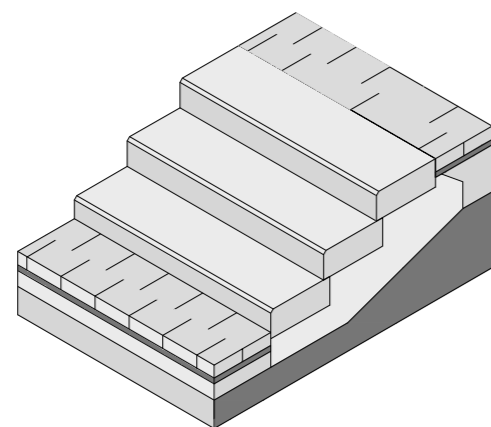
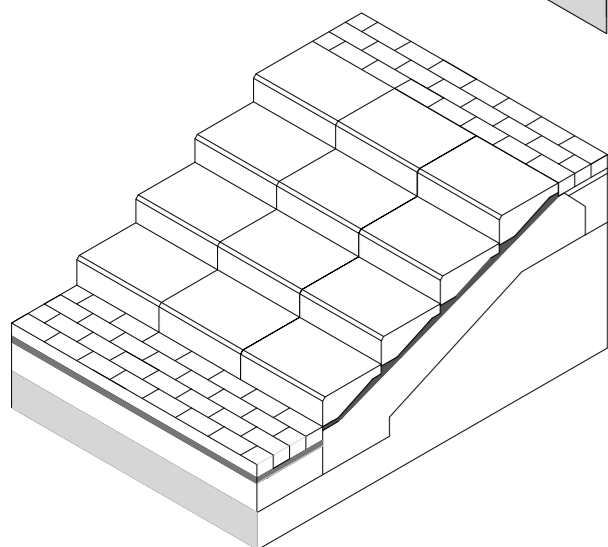
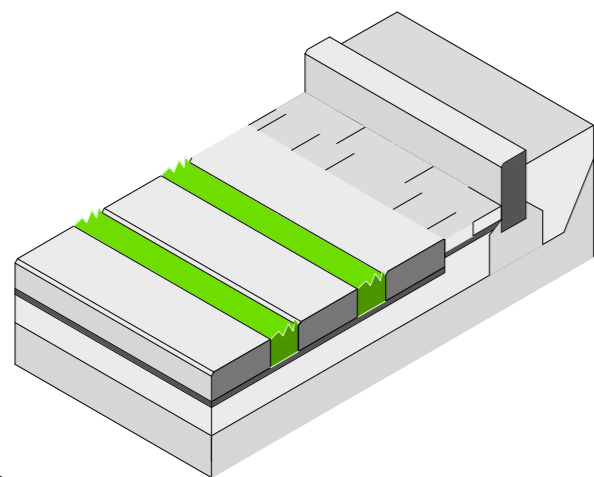

MODELO P51
50x36x15
Peso 42 KG

CARACTERISTICAS GEOMETRICAS

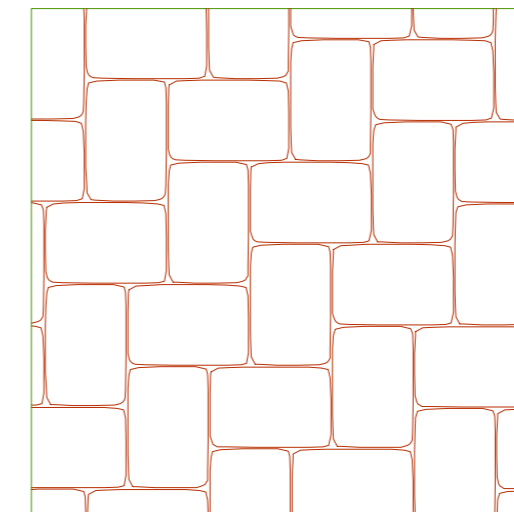

Patron a 90° utilizando una única medida de TEGULA ART 24x16x6 para areas de trafico pesado.

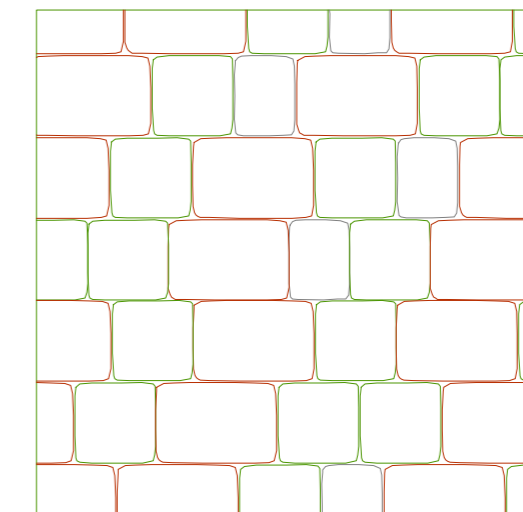

Combinacion aleatoria de las tres medidas del TEGULA ART 24x16x6, 16x16x6 y 16x12x6

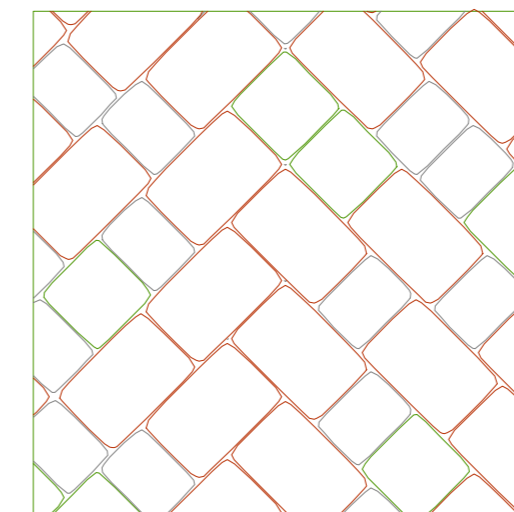

Combinación a 90° utilizando las tres medidas de TEGULA ART para areas de trafico pesado.

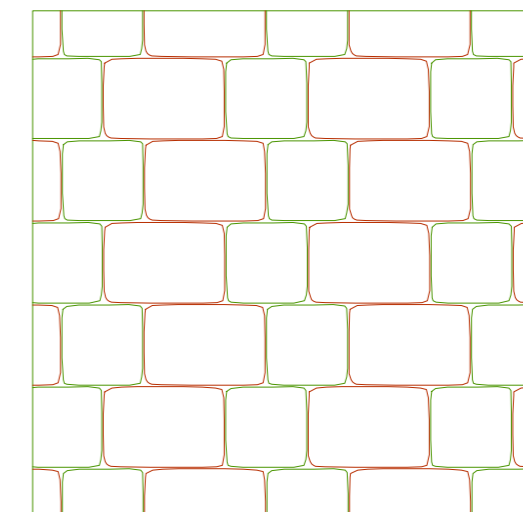

Combinacion dos medidas de TEGULA ART 24x16x6 y 16x16x6 .

TERANA ART

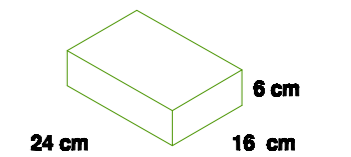

24 cm 16 cm 6 cm

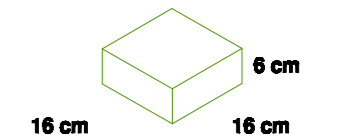

16 cm 16 cm 6 cm

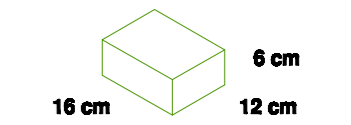

16 cm 12 cm 6 cm



AJUNTAMENT D'AVINYONET DE PUIGVENTÓS

PROJECTE BÀSIC I EXECUTIU
ESCALES D'ACCÉS AL CARRER DE LES ILLES

REFERENCIA: 0373-11

DATA: JULIOL 2011

MUNICIPI: AVINYONET DE P.

COMARCA: ALT EMPORDÀ

DETALLS PAVIMENTS

PLANOL NUM:

8

ESCALA:

Francesc Oliva i Sans
ARQUITECTE
Roser Masó Guisot
ARQUITECTE TÈCNIC

ESQUEMA DE COLOCACION